

**PRODUCT CODE: MP9**  
CHANNEL BRACKET

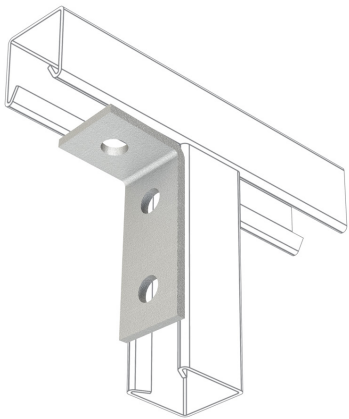

**DESCRIPTION**

1 + 2 Hole 90° Bracket

**FINISH**

Hot Dipped Galvanised

**MATERIAL**

Steel

**PACKAGING**

Packed in qty 25

**ADDITIONAL NOTES**

Compliant to LU Standard 1-085 (for use on surface & sub-surface locations)

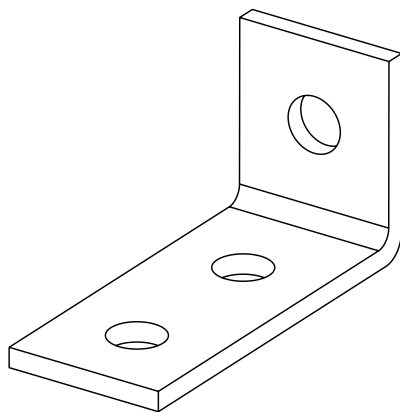

Isometric view

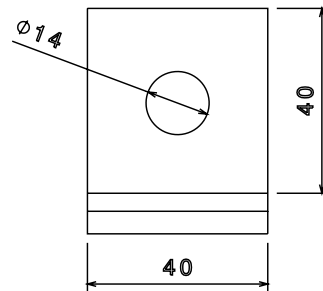

Front view

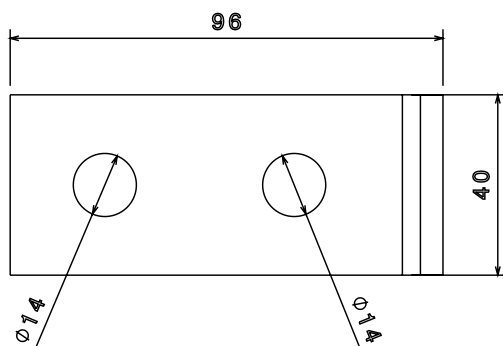

Top view

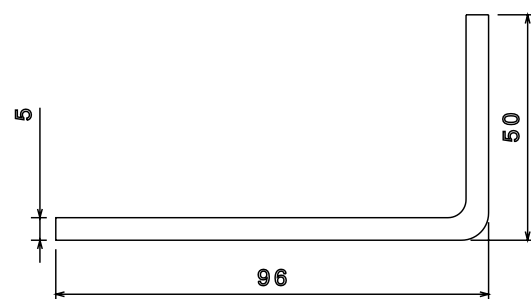

Side view